

C&K Rafx 16 Series Non-illuminated & Illuminated Pushbutton Switches

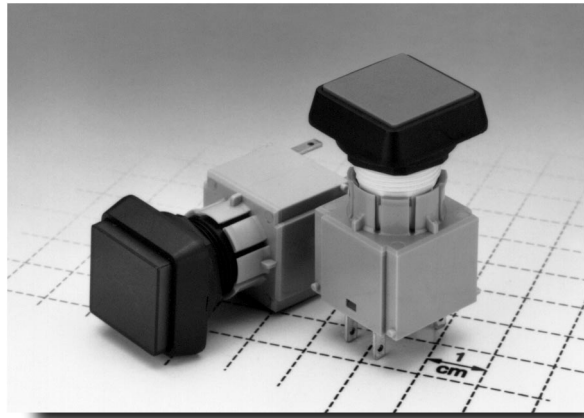

Features/Benefits

- Large actuation surface
- Latching & momentary models available
- Snap-together design—easy assembly
- Long operating life—up to 2,000,000 cycles

Typical Applications

- Machine process control
- Textile machinery
- Metal working machinery

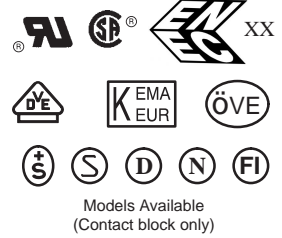

How To Order

To order, select actuator and contact block part numbers. Accessories, filament lamps and LEDs available separately, see catalog section L. Other frame styles, contact arrangements, lens colors and flush models available, consult Customer Service Center.

Specifications

CONTACT RATING: Ag: 6 AMPS @ 250 V AC.
Au: 250 mA @ 42 V AC/DC.
CONTACT SYSTEM: Self cleaning bridge contact.
CONTACT ARRANGEMENT: 1 N.C. & 1 N.O./2 N.O./2 N.C.
CONTACT RESISTANCE: Ag: 20 milliohms; Au: < 50 milliohms.
ILLUMINATION: Wedge base filament lamp.
FIXING: Hexagon nut.
OPERATING LIFE: Latching: 100,000 cycles.
Momentary: 2,000,000 cycles.
OPERATING FORCE: Approximately 6N.
OPERATING TEMPERATURE: Non-illuminated: -25°C to +70°C;
-13°F to +158°F. Illuminated: -25°C to +55°C; -13°F to +131°F.
FULL TRAVEL: Approximately 3mm.
SWITCHING TRAVEL: Approximately 3mm.
DEGREE OF PROTECTION: IP65; dust-proof, water splash and dew condensation.

Materials

SWITCH HOUSING: PA
COLLAR: PBTB.
CONTACT BLOCK HOUSING: PA 12.
LENS: PA 12.
CONTACT MATERIAL: Silver nickel/gold.
TERMINALS: Quick connect 2.8 x 0.8 tin plated.
FLAMMABILITY OF PLASTIC MATERIALS: UL 94V0.

Non-illuminated Pushbutton Switches with Flush Lens



1.30070.2510104

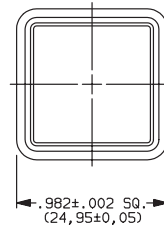
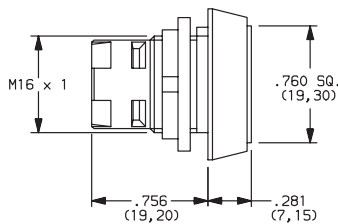

PANEL MOUNTING

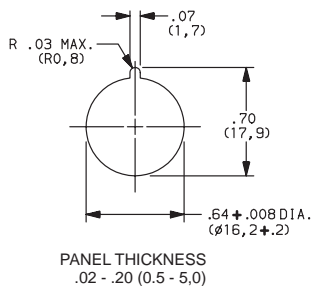

NON-ILLUMINATED SWITCHES	
PART NUMBER	COLOR
1.30070.2510104	Black
1.30070.2510215	White
1.30070.2510301	Red
1.30070.2510403	Yellow
1.30070.2510525	Green
1.30070.2510617	Blue

For contact block, see page B-87.

C&K Rafx 16 Series Non-illuminated & Illuminated Pushbutton Switches

Standard Contact Block for Non-illuminated Pushbutton with Flush Lens

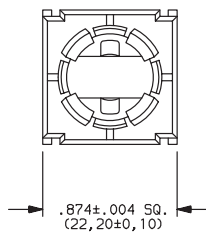
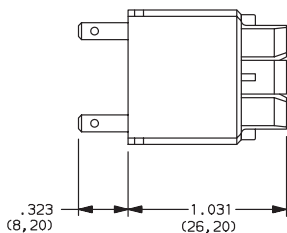

1.20122.0210000
1 N.C. + 1 N.O.

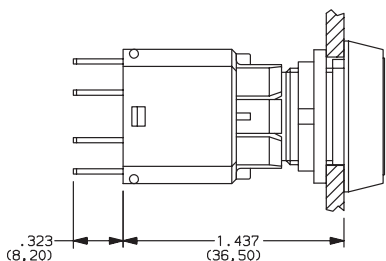

Standard Contact Block &
Non-illuminated Pushbutton with Flush Lens

STANDARD CONTACT BLOCK FOR NON-ILLUMINATED PUSHBUTTON			
PART NUMBER	FUNCTION	MATERIAL/ CONTACT RATING	CONTACT ARRANGEMENT
1.20122.0210000 1.20122.0220000 1.20122.0230000	Momentary	Silver 250 V/6 A (4 A)	1 N.C. & 1 N.O. 2 N.O. 2 N.C.
1.20122.0610000 1.20122.0620000	Latching		1 N.C. & 1 N.O. 2 N.O.
1.20122.0310000 1.20122.0320000 1.20122.0330000	Momentary	Gold 42 V/250 mA	1 N.C. & 1 N.O. 2 N.O. 2 N.C.
1.20122.0710000 1.20122.0720000	Latching		1 N.C. & 1 N.O. 2 N.O.

Illuminated Pushbutton Switches with Flush Lens

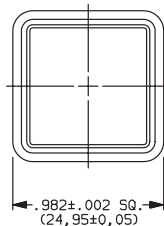
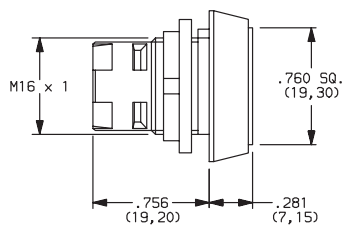

1.30070.0011002

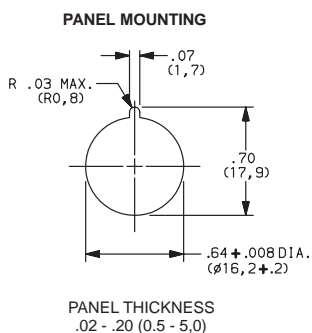

ILLUMINATED SWITCHES	
PART NUMBER	COLOR
1.30070.0011002	Colorless
1.30070.0011306	Red
1.30070.0011403	Yellow
1.30070.0011505	Green
1.30070.0011607	Blue

For contact block, see page B-88.



B

Pushbutton

C&K Rafx 16 Series Non-illuminated & Illuminated Pushbutton Switches

Standard Contact Block for Illuminated Pushbutton with Flush Lens



1.20122.0010000
1 N.C. + 1 N.O.

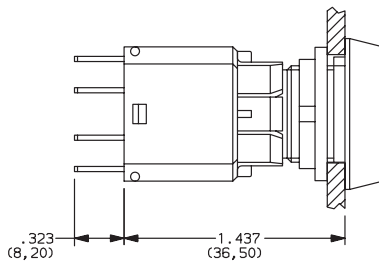
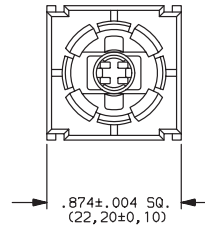
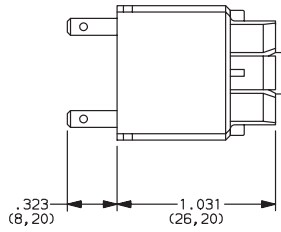

Standard Contact Block &
Illuminated Pushbutton with Flush Lens

STANDARD CONTACT BLOCK FOR ILLUMINATED PUSHBUTTON3			
PART NUMBER	FUNCTION	MATERIAL/ CONTACT RATING	CONTACT ARRANGEMENT
1.20122.0010000 1.20122.0020000 1.20122.0030000	Momentary	Silver 250 V/6 A (4 A)	1 N.C. & 1 N.O. 2 N.O. 2 N.C.
1.20122.0410000 1.20122.0420000	Latching		1 N.C. & 1 N.O. 2 N.O.
1.20122.0110000 1.20122.0120000 1.20122.0130000	Momentary	Gold 42 V/250 mA	1 N.C. & 1 N.O. 2 N.O. 2 N.C.
1.20122.0510000 1.20122.0520000	Latching		1 N.C. & 1 N.O. 2 N.O.



B

Pushbutton